

BDC BAHRAIN DRIFT CHAMPIONSHIP TECHNICAL REGULATION

1. Eligible cars

1.1. Pro and Semi-Pro

Eligible Vehicles must be considered a “Production Vehicle”. Eligible body styles include: coupe, sedan, station wagon, have no more than 5 doors.
Vehicles must maintain the original OEM unibody/chassis and / or frame structure between the OEM front and rear suspension mounting points.

1.2. Street

Eligible Vehicles must be considered a “Production Vehicle”. Eligible body styles include: coupe, sedan, station wagon, have no more than 5 doors.
Vehicles must maintain the original OEM unibody/chassis and / or frame structure between the OEM front and rear bumper mounting points.
Vehicles must maintain the original OEM interior.

2. AUTHORISED MODIFICATIONS AND ADDITIONS

These regulations are written in terms of authorisation: therefore, what is not expressly authorised hereinafter is prohibited.

3. DIMENSIONS, WEIGHT, BALLAST

Categories	Minimum Weight	Maximum Weight
Pro	950 kg	N/A
Semi Pro	N/A	N/A
Street	N/A	N/A

3.1

3.2. BALLAST

Ballast permitted. Maximum allowable ballast 25 kg. Ballast must only serve the unique purpose of adding weight to the Vehicle. Ballast must only be mounted between front and rear axle. Ballast Blocks must weight no less than 5 kg each and cannot be made of liquid or any type of pellets or granulated material. Ballast must be securely fastened with a minimum of two (2) 8mm – 8.8 Grade bolts per 5 kg, attached to the Chassis. No weight shifting devices are allowed including but not limited to hydraulic, pneumatic or electronic devices.

4. ENGINE

4.1. Pro and Semi-Pro

Only one internal-combustion automotive-type engine permitted. Engine substitutions and modifications are free but may only run-on petrol or ethanol blends.

4.2. Street

Only one internal-combustion automotive-type engine permitted. Engine modifications are free but may only run-on petrol.

5. FLYWHEEL

The use of flywheels certified for Motorsport is recommended.

6. TURBOCHARGER

Any kind of automotive Turbocharger permitted. Turbocharger must remain unaltered in manufacturer condition.

7. SUPERCHARGER / PRO-CHARGER

Any kind of automotive Supercharger or Pro-Charger permitted. Supercharger or Pro-Charger must remain unaltered in manufacturer condition. Manufacturer Overdrive limits apply.

8. NITROUS OXIDE

If the use of Nitrous Oxide is permitted. Maximum one Nitrous bottle limited to 20lbs. permitted. If installed in driver compartment, bottle must be equipped with a relief valve and vented outside of driver's compartment.

The Bottle must be stamped with a CE or DOT marking, must have a minimum 124 bar rating and must be securely mounted by a minimum of 2 screw-locked metallic straps (no hose clamps or tie wraps). Anti-torpedo tabs are required. The hoses from the bottle to the solenoid must be high pressure, steel braided or FIA accepted.

A Hobbs switch or an equivalent system is mandatory and must be installed so that the nitrous system may only be activated when there is sufficient fuel pressure.

Commercially available, thermostatically controlled, blanket-type warmer accepted. Any other external heating of the bottle is prohibited.

All vehicles using a bottle of nitrous oxide must bear a sticker according to Drawing - 001. The sticker must be clearly visible and will be located in a place which is unlikely to be damaged in the event of an accident and which is near to the competition number.

The legal requirements of the hosting country concerning the use and handling of Nitrous Oxide must be obeyed at all times.



001

9. FUEL - FUEL SYSTEM

Unleaded Racing fuel, ethanol permitted. The use of Diesel, natural gas or propane is prohibited.

9.1. FUEL SYSTEM - LOCATION

All fuel cells, lines, pumps, valves, etc. must be outside the Drivers compartment and within the confines of the Vehicles structure.

Fuel-distribution blocks and fuel-pressure gauge isolators must be located at least 150mm forward of the flywheel area. Only Fuel pressure isolators, with steel braided lines, may be mounted on firewall.

9.2. FUEL CELL

All non-OEM fuel cell/tank must meet the FIA Standard FT3, FT3.5, FT5-1999 mandatory. Only one Fuel Cell permitted.

Fuel cell must be vented to outside of the body.

The fuel cell, the filling and ventilation systems must be separated from the cockpit by a fireproof and liquid- proof protective device.

Fuel cell must have positive-lock cap.

Fuel cell must be securely mounted and be at least 200mm inside of the Vehicles structure.

Artificial cooling or heating systems (i.e. cool cans, ice, Freon, etc.) prohibited.

Circulating systems, not part of normal fuel-pump system, prohibited.

Fuel Cell must be bladder type.

Pressurized refiling is prohibited.

The ventilation line of the fuel cell as far as the valves described below must be fitted with a system complying with the following conditions:

- Gravity activated roll-over valve
- Float chamber ventilation valve
- Blow-off valve with a maximum over pressure of 200 mbar, working when the float chamber ventilation

9.3. FUEL LINES

All non-OEM fuel lines (including gauge and/or data recorder lines) must be metallic, steel or nylon braided and be fitted with AN hose ends. No Fuel line may be routed through the Drivers compartment.

9.4. FUEL PUMP

Vehicles with a non-OEM-type mechanical fuel pump must have a quick-action fuel shutoff valve within easy reach of driver and located in the main fuel line between the fuel tank and the carburettor and/or injectors.

Fuel recirculation systems not part of the normal fuel/pump system prohibited.

All electric fuel pumps must only operate when the engine is running, except during the starting process.

4.6. INDUCTION

Any induction permitted. Electronic fuel injection may monitor engine functions only. Open-loop systems permitted on production Vehicles as equipped with OEM electronic fuel injection. Utilization of vehicle performance criteria, wheel speed, prop shaft speed, vehicle acceleration, etc. by fuel-injection system prohibited.

10. LIQUID OVERFLOW

Catch-can mandatory for coolant overflow, 1ltr. minimum capacity required. Must be placed outside Drivers compartment.

11. CHASSIS / UNIBODY

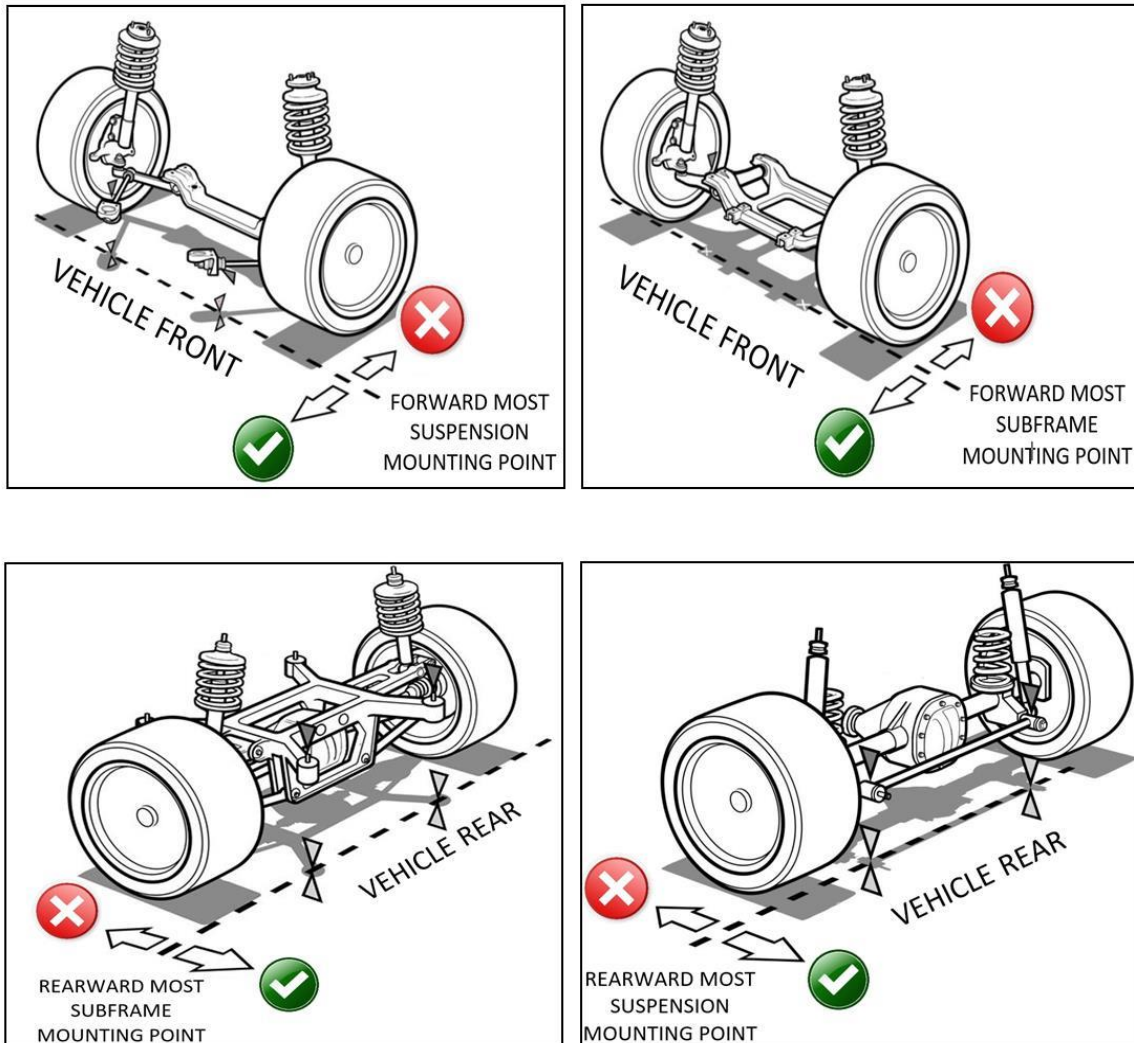

002

The original OEM floor pan, frame and/or unibody must remain structural unmodified in the area between the horizontal planes created by the original floor pan at the lowest horizontal plane to the roof at its highest horizontal plane.

Items in the unmodified area that are allowed to be removed can include original rear window parcel shelf, mounts for unused OEM steering columns, unused OEM windshield wiper mounts. It is permitted to replace the exterior roof panel with a composite panel. No other structural modifications to the chassis permitted except its approved by the Technical Delegate/Scrutineering.

11.1. BUMPER FRAME

All Vehicles must be equipped with front and rear bumper frames unless OEM Bumper incl. OEM Bumper frame/support is used and attached at the OEM attachment points.

Bumper frames must be constructed of min. 25mm to max. 44mm od. Steel tubing with a wall thickness of min. 1.6mm to max. 3.2mm. All bumper frame tubing must remain hollow.

Bumper frames must be fastened to the Vehicle with a minimum of four (4) 10mm fasteners/bolts per side (minimum Grade 8.8) or welded to prevent the bumper frame from being dislodged from the Vehicle.

Bumper frames must be rounded off or capped off to prevent becoming locked or piercing another Vehicle.

Bumper frames must at minimum span the width of the front and rear frame rails. Tubing must not be exposed and must remain behind the bumper covers with maximum clearance of 50mm between the bumper cover and the bumper frame itself.

Bumper must be fixed, the use of shock absorbers, dampers, springs, pivots and slip joints is not permitted unless OEM.

Bumper frames must remain in the confines of the body lines and body work without additional covers or body work extensions in order to do so.

11.2. AIR JACKS / LIFTING DEVICE

Air Jacks and/or other automated lifting devices are prohibited.

11.3. TOWING EYE

All Vehicles must be equipped with a rear and front towing-eye which is capable of sustaining a minimum 1.5 times of the Vehicle gross weight.

The towing eye must not protrude more than 75mm out of the silhouette of the bodywork if made of metal.

It must be clearly visible and painted in yellow, red or orange or must be indicated on the bodywork.

11.4. FIREWALL

A Firewall is mandatory. Firewall must be constructed of minimum 0.8mm Steel or 1.5mm Aluminium. Any holes in the firewall must be of the minimum size for the passage of controls and/or wires and must be completely sealed to prevent the passage of fluids or flames from the engine compartment to the Drivers compartment.

11.5. FIREWALL / TRANSMISSION TUNNEL MODIFICATIONS

Firewall and Transmission Tunnel modifications permitted as per Drawing – 003.

The taper length from the firewall to the end of the transmission tunnel into the beginning of the drive shaft tunnel may be no longer than 915 mm. All modifications to the firewall and transmission/drive shaft tunnel must be carried out using min. 0.8mm steel or 1.5mm aluminium.

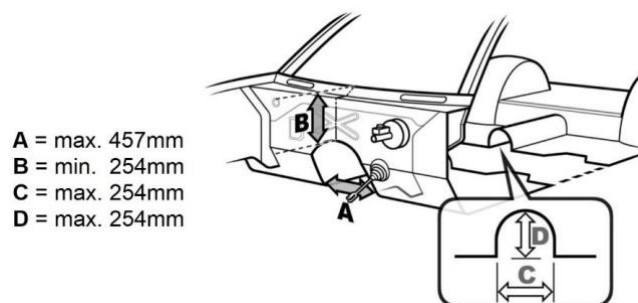

003

11.6. BODYWORK GENERAL

Aftermarket body panels, front and / or rear fascia's, side skirts and wings are permitted. All additional body panels must be securely fastened and must correspond with the OEM Body shape. One-piece front end (flip - front) prohibited.

11.7. BUMPER COVERS

The bumper covers (front & rear) must cover the structure of the bumper frame. The bumper covers must be attached at a minimum of four points to the Bodywork or Chassis.

The use of cable ties for attachment purpose is permitted.

The Vehicle must be equipped with both (front & rear) bumpers prior to the start of the event.

11.8. DOORS

Driver side and Passenger Side Door mandatory, may be made from composite material. The Inside and outside door latch / lock mechanism must be operable in all circumstances and clearly visible on both, the driver and passenger side.

OEM unmodified Door hinge and Door latch mandatory.

No modifications on street class and must maintain as OEM.

11.9. MIRRORS

External Driver and passenger side mirror mandatory.

11.10. WINGS

Wings must not be wider than and must be confined within the silhouette of the Bodywork.

Wings must be securely bolted to the Vehicle, the use of quick release pins is prohibited.

Maximum size of rear wing spill plate not to exceed 300mm x 400mm. Maximum distance between the main element and the Deck lid not to exceed 400mm.

The installation of the rear Wing may not obstruct the view from any angle, or the operation of any safety device, signalling light, indicator, or other equipment.

Wings with standoffs must have the endplates and the wing tethered with independent cables to the Vehicle.

11.11. HOOD & TRUNK LID

Hood and Trunk lid may be constructed from composite material. Hood must be secured by OEM hinges and two fasteners.

The original locking mechanisms must be rendered inoperative or removed.

12. TRANSMISSION**12.1. TRANSMISSION MOUNTING**

Optional.

12.2. TRANSMISSION SPECIFICATION

All vehicles must be equipped with a functional reverse gear. Transmission and/or final drive modifications are free, but only the rear wheels may propel the vehicle.

Clutch release must be manually operated initiated by the driver's foot. Automatic transmission prohibited.

Automated, timer-type, pneumatic, electric, electronic, hydraulic, etc. shifting mechanism prohibited.

Each individual shift must be a function of the driver and be controlled manually.

12.3. CLUTCH ASSEMBLY

The use of multi disc clutch systems permitted. The function of the clutch must be controlled by the driver's foot only.

No automated clutch release permitted. The use of clutch systems certified for Motorsport is recommended.

13. DRIVE TRAIN

13.1. DRIVE TYPE

Only the rear-wheels may propel the vehicle.

All-wheel drive or Front-wheel drive vehicles may be converted to rear-wheel drive.

No modifications on street class and must maintain as OEM.

13.2. DRIVESHAFT LOOP

Driveshaft loop mandatory. Each end of the driveshaft must have a driveshaft loop with 360° enclosure.

Each Loop must be made of min. 51mm x 6.35mm steel flat strap or 1.6mm x 22mm welded steel tubing, be securely mounted to the OEM floor and located within 152mm of the front and rear universal joint in order to support the driveshaft in the event of a U-joint failure. See Drawing – 004.

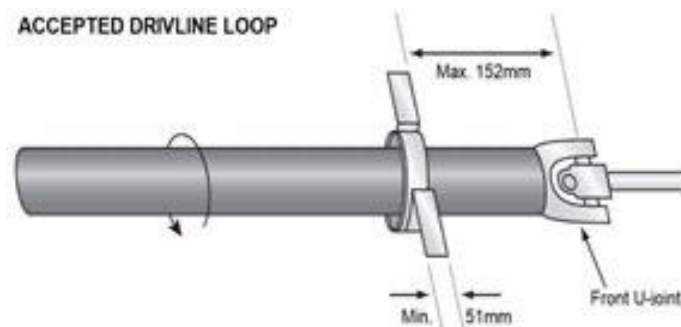

004

13.3. REAR AXLE DIFFERENTIAL – FINAL DRIVE

Aftermarket Differential permitted. Differential must be securely mounted in original position. Gear ratio of rear axle may be altered during competition. Welding of Side Gears and Spider gears is strictly prohibited.

14. BRAKES - STEERING

14.1. BRAKES

Four-wheel hydraulic brakes mandatory on all vehicles. Dual master cylinders pedal assemblies permitted.

Driver adjustable brake bias between front and rear axle permitted.

Carbon fibre, carbon ceramic, and carbon variant brakes or rotors are prohibited.

Hydraulic Handbrake for rear brakes permitted for Pro and Semi Pro.

Hydraulic shut-off valves prohibited.

14.2. STEERING

Modification of Steering components permitted.

OEM Steering lock must be removed.

No modifications on street class and must maintain as OEM.

15. SUSPENSION GENERAL

In Car, Driver adjustable suspension prohibited.

No suspension changes or adjustments (including remotely) by any means are permitted between battle runs.

Examples include but not limited to sway bars and electronic shock / damper adjusters.

15.1. FRONT SUSPENSION

Modification permitted. Any modification of the suspension design type must be permitted by the Technical delegate.

Minimum one hydraulic shock absorber per wheel mandatory.

15.2. REAR SUSPENSION

Original suspension design type must remain.

Minimum one hydraulic shock absorber per wheel mandatory.

16. SAFETY CAGE

16.1. SAFETY CAGE - GENERAL

The use of a safety cage is mandatory for Pro class and recommended for others. The safety cage must be identifiable by means of an identification plate affixed to it by the manufacturer; this identification plate (i.e. embedded or engraved metallic plate) must be welded to the lower part of the driver side front roll bar. The identification plate must bear the name of the manufacturer, the month and year of production and an individual serial number.

16.2. SAFETY CAGE - DEFINITIONS

16.2.1. Safety cage:

A Multi-tubular structure installed in the cockpit and fitted close to the body shell, the function of which is to reduce the deformation of the body shell (chassis) in case of an impact. Plating of the safety cage is prohibited.

Main roll bar:

Transverse and near-vertical (maximum angle $\pm 10^\circ$ to the vertical) single piece tubular hoop located across the vehicle just behind the front seats. The tube axis must be within one single plane.

16.2.2. Front roll bar:

Similar to main roll bar but its shape follows the windscreen pillars and top screen edge. The lower part of the pillar must be near-vertical with a maximum angle of 10° to the vertical towards the rear. At the mounting foot, the tube must not be rearward of the foremost point of the roll bar.

16.2.3. Lateral roll bar:

Near-longitudinal and near-vertical single piece tubular hoop located along the right or left side of the vehicle, the front pillar of which follows the windscreen pillar and the rear pillar of which is near-vertical (maximum angle $\pm 10^\circ$ to the vertical) and located just behind the front seats. The rear pillar must be straight in side view. The lower part of the front pillar must be near-vertical with a

maximum angle of 10° to the vertical towards the rear. At the front mounting foot, the tube must not be rearward of the foremost point of the roll bar.

16.2.4. Removable members:

Removable members (Bolt in tubes) if used must be installed according to 2020 Appendix J Art. 253-8.3.2.4. of the International Sporting Code.

16.2.5. Mounting foot plate:

The safety cage shall attach to the chassis in eight (8) mounting points. A 2mm thick Plate minimum 120cm² in size, welded to the end of a safety cage tube to permit its mounting to the body shell or chassis, usually onto a reinforcement plate. This plate may be welded or bolted to the body shell / chassis. When the safety cage or parts of it is bolted to the chassis, 2020 Appendix J Art. 253-8.3.2.6. of the International Sporting Code must be followed.

Reinforcement plate: Metal plate fixed to the body shell/chassis under a roll bar mounting foot.

16.2.6. Gussets:

Gussets of such as dimple die plates are allowed along A-pillar, B-pillar, and roof structure. Dimple plate gussets must be made from steel plate no thicker than 3mm. No gussets or attachment of any form may pass from the door bars to the chassis, unibody or rocker panel. See 2020 Appendix J Art. 253-8.2.14. of the International Sporting Code for additional information.

16.3. SAFETY CAGE - SPECIFICATIONS

Basic structure

The base structure must be constructed according to one of the following designs:

- **Base structure 1:** 1 main roll bar-1 front roll bar-2 longitudinal members-2 backstays-6 mounting feet
- **Base structure 2:** 2 lateral roll bars-2 transverse members-2 backstays-6 mounting feet
- **Base structure 3:** 1 main roll bar-2 lateral half-roll bar-1 transverse member-2 backstays-6 mounting feet

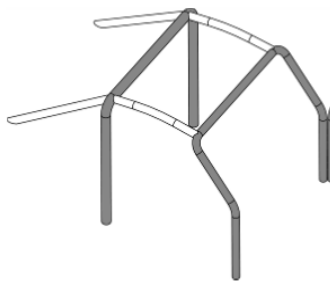

Base structure 1

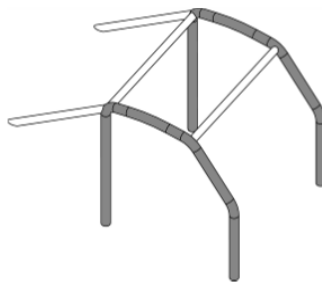

Base structure 2

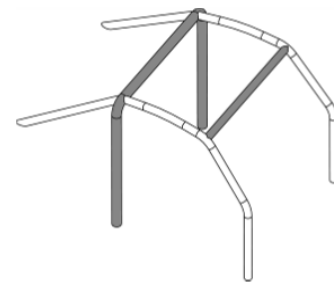

Base structure 3

005

The near-vertical part of the main roll bar (or the rear pillar of the lateral roll bar) must be as close as possible to the inner side panels of the body shell and must have no more than one bend. The pillar of the front roll bar (or the front pillar of a lateral roll bar or half-roll bar) must follow the windscreen pillar as closely as possible and must have no additional bends below that where it ceases to follow the windscreen pillar.

The following connections must be situated at the roof level:

- Longitudinal members to the front and main roll bars
- Transverse members to the lateral roll bars
- Semi-lateral roll bar to the main roll bar

The backstays must be attached at the roof level and near the top outer bends of the main roll bar, on both sides of the car. They must form an angle of at least 30° with the vertical, must run rearwards and be straight and as close as possible to the inner side panels of the body shell.

16.4. COMPULSORY MEMBERS AND REINFORCEMENTS

Diagonal members:

The safety cage must have two diagonal members on the main roll bar according to the Drawing - 006 Members must be straight and may be removable. The lower end of the diagonal must join the main roll bar no further than 100 mm from the mounting foot. The upper end of the diagonal must join the main roll bar no further than 100 mm from its junction with the backstay.

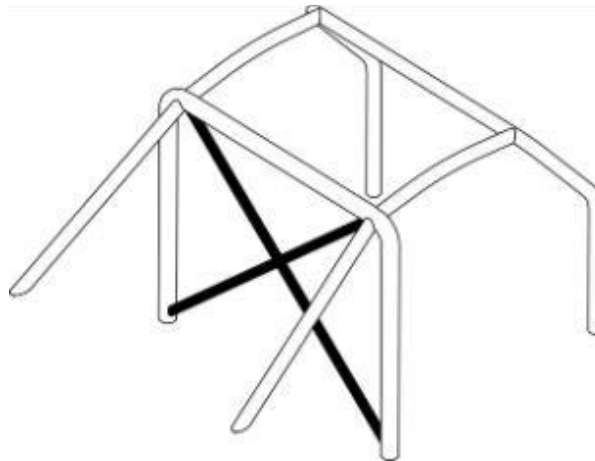

006

16.5. Roof reinforcement:

The upper part of the safety cage must be reinforced with members according to one of the Drawings – 007, 008 or 009.

The members may follow the curve of the roof. For competitions without co-drivers, in the case of Drawing 102-10, only one diagonal member may be fitted but its front connection must be on the driver's side. The ends of the members must be less than 100 mm from the junction between roll bars and members of the base structure (not applicable to the top of the V formed by reinforcements in Drawings - 008 and 009).

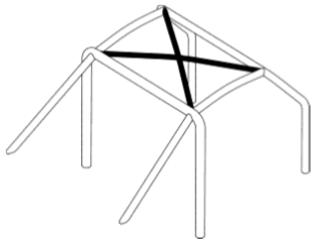

007

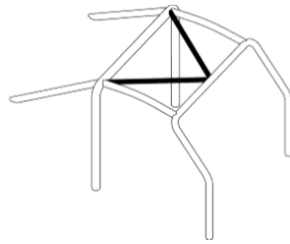

008

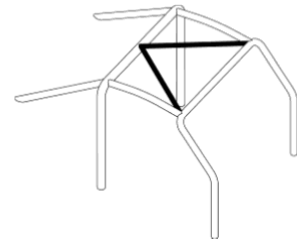

009

16.6. Door bars Side protection:

Longitudinal members (Door bars) must be fitted on each side of the vehicle according to Drawings – 010, 011 or 012. Drawings may be combined.

One longitudinal member may be added to each of the designs shown in the Drawings below. The design must be identical on both sides.

They Tubes may be removable in lieu of 2020 Appendix J Art. 253-8.3.2.4. of the International Sporting Code.

The Side protection must be as high as possible, but its upper attachment point must not be higher than half the height of the door opening measured from its base.

If these upper attachment points are located in front of or behind the door opening, this height limitation applies to the corresponding intersection of the member and the door opening (side view).

In the case of Drawing - 010, it is required that at least one part of the "X" is a single Tube.

In the case of Drawing - 011, the door bars may also run parallel.

In the case of Drawing - 010, 011 and 012, it is required that the attachment points of the longitudinal members are directly connected to the front and the main roll bar uprights.

If the two door bars do not intersect as they do when forming an "X" shown in Drawing - 010, then a minimum of two vertical tube sections shall connect the upper and lower door bars as shown in Drawing - 011. "NASCAR-Style" Side protection bars, which extend into the outer door skin as shown in Drawing - 012 are permitted. If the "NASCAR-Style" configuration is used, the outer bars must have a minimum of three vertical tube sections connecting the upper and lower door bars. In the case of Drawing - 012, it is not mandatory that the upper and the lower longitudinal members are parallel.

The connection of the door bars to the windscreen pillar reinforcement (if used) is permitted.

Under no circumstances may any of the Door bar Side protection penetrate the "A" or "B" pillar of the chassis.

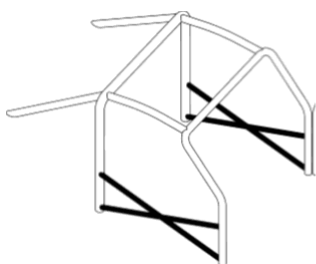

010

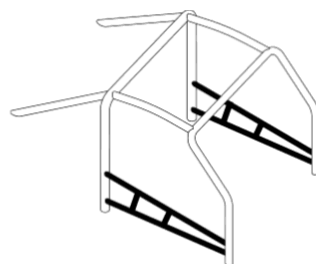

011

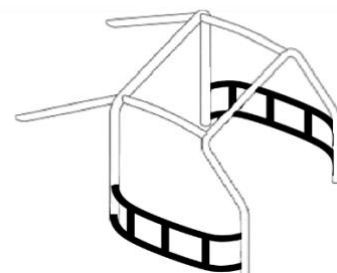

012

16.7. Windscreen pillar reinforcement:

A Windscreen pillar reinforcement is required in all safety cages on each side of the front roll bar if dimension "A" in Drawing - 013 is greater than 200 mm. It may be bent on the condition that it is straight in side view and that the angle of the bend does not exceed 20°.

Its upper end must be less than 100 mm from the junction between the front (lateral) roll bar and the longitudinal (transverse) member. Its lower end must be less than 100 mm above the (front) mounting foot of the front (lateral) roll bar.

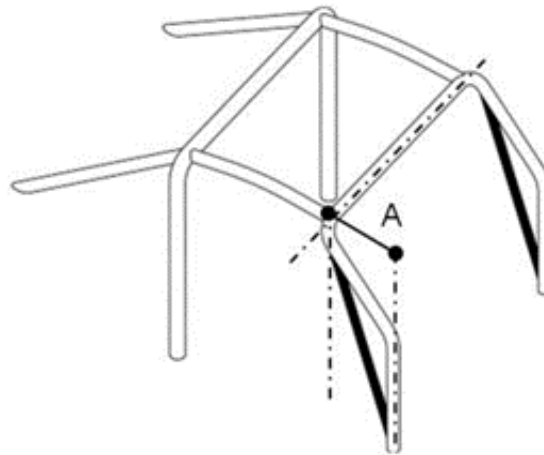

013

16.8. Anti-intrusion Bars:

The anti-intrusion bars are intended for additional foot protection.

All vehicles must be equipped with anti-intrusion bars which must connect in two places at the lower part of the front roll bar and the firewall but not penetrating any panel. See Drawing - 014.

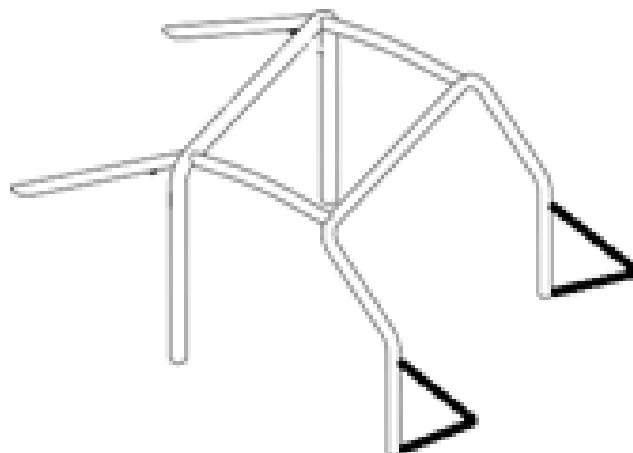

014

16.9. ADDITIONAL MEMBERS AND REINFORCEMENTS

Any number of additional reinforcing tubes, gussets or supports within the confines of the safety cage permitted.

Additional reinforcements must comply with 2020 Appendix J Art. 253-8 of the International Sporting Code.

16.10. SAFETY CAGE TUBE SPECIFICATIONS

Material	Min. tensile strength	Minimum dimension	Use for
Cold drawn seamless unalloyed carbon steel (see below) containing a maximum of 0.3 % of carbon	350 N/mm ²	45 x 2.5mm (1¾ x .095") or 50 x 2.0mm (2 x .083")	Main roll bar or Lateral roll bars and rear transverse members
		38 x 2.5mm (1½ x .095") or 40 x 2.0mm (1¾ x .083")	Lateral half-roll bars and other parts of the safety cage

16.11. NOTE:

For unalloyed steel, the maximum content of additives is 1.7 % for manganese and 0.6 % for other elements. In selecting the steel, attention must be paid to obtaining good elongation properties and adequate weld ability. The tubing must be bent by a cold working process and the centreline bend radius must be at least 3 times the tube diameter. If the tubing is ovalised during bending, the ratio of minor to major diameter must be 0.9 or greater. The surface at the level of the bends must be smooth and even, without ripples or cracks.

16.12. Guidance on welding:

Welding must be carried out along the whole perimeter of the tube on all connections (except where bolt in is permitted). All welds must be with full penetration using the gas-shielded Tungsten Inert Gas welding process. The grinding of welds is prohibited. When using heat-treated steel, the special instructions of the manufacturers must be followed.

16.13. SAFETY CAGE PADDING

The driver side of all tubes of the cage identified on Drawing - 015 in red and all roof reinforcements must be fitted with padding in compliance with FIA standard 8857-2001 type A (see Technical List n°23).

Each padding must be fixed in such a way that it is not moveable from the tube.

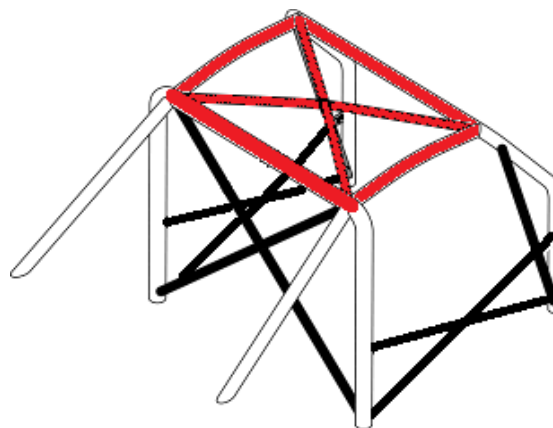

015

17. TIRES AND WHEELS

17.1. TIRES

Tires must be of automotive type with DOT or EU rating. The use of tire warmers, chemical treatments, or any means to artificially enhance tire performance is prohibited including grooving or shaving.

17.2. WHEELS

Must be automotive-type wheels suitable for street use. Minimum wheel size: 15 inches (unless originally equipped with smaller wheels and Vehicle is equipped with original engine). The thread engagement on all wheel studs to the lug nut, or lug bolt to wheel hubs, must be equivalent to or greater than the diameter of the stud. Length of the stud/bolt does not determine permissibility; length of the engagement between the stud and lug determines permissibility. Automotive-type wire, centre lock or mono lock wheels prohibited. Bead locks, wheel screws and any means of any kind of attachment between wheel and tire is prohibited. Use of Wheel Spacers permitted, only one spacer per wheel.

Spacers with a thickness greater than 20mm must be equipped with their own mounting bolts to the hub. The maximum permitted spacer thickness is 60mm per wheel.

18. INTERIOR

18.1. SEATS, ANCHORAGE POINTS AND SUPPORTS

Driver Seat must comply with FIA Standard 8855-1999, 8855-2021 or 8862-2009. See Appendix J Art. 253-16 of the International Sporting Code for fitting and mounting instructions. No passengers permitted during competition.

18.2. DRIVERS COMPARTMENT

The Drivers Compartment must be designed in such a way as to allow the driver wearing his complete driving equipment, being seated in a normal driving position with the seat belts fastened and the steering wheel in place to escape out of the Vehicle in maximum 8 seconds through the Driver Side Door,

or in maximum 14 seconds through the Passenger Side Door.

No pressurised containers (except Fire Extinguisher system or fresh air supply) permitted in the Drivers Compartment.

18.3. SHEET METAL

Driver compartment interior must be aluminium, steel or composite material accepted by the technical delegate/scrutineer. Magnesium prohibited.

19. BODY

19.1. WINDSHIELD

Mandatory, must be in good condition and free from cracks. May be replaced with shatterproof material, 4.5mm minimum thickness securely bolted in place. Windshield may not be cut for scoops, carb, etc.

Windshield tint is prohibited.

19.2. WINDOWS

Door, quarter and rear window must be OEM glass or shatterproof material with minimum thickness of 3mm and securely bolted in place. Front driver and passenger side windows not mandatory. Side windows and rear windows must be clear, use of tint or wrap is prohibited.

20. ELECTRICAL

Batteries (max. two) may not be located in driver compartment. Each Battery must be securely fastened to the frame or unibody with a minimum of two 8mm bolts.

20.1. CIRCUIT BREAKER

Mandatory on all Vehicles. The general circuit breaker must cut all electrical circuits (battery, alternator or dynamo, lights, ignition, electrical controls, etc.) and must also stop the engine. It must be a spark-proof model and must be accessible from inside (in Drivers reach) and outside the Vehicle. As for the outside, the triggering system of the circuit breaker must compulsorily be situated at the lower part of the windscreen mountings on the driver side A-pillar. It must be marked by a red spark in a white-edged blue triangle with a base of at least 120mm. See Drawing -016.



016

20.2. LIGHTS

All OEM lights must remain in place, Headlights, taillights and brake lights must function normally. Brake lights and taillights may only be red, tinting is prohibited. Rearward facing strobe lights of any colour is strictly prohibited. Any variation of red and or orange-coloured headlights is prohibited.

20.3. SUPPORT GROUP/COMPUTER

The choice of the engine Electronic control unit (ECU), engine control software, sensors and engine loom is free.

During competition, a portable computer (e.g. laptop, PDA, Palm Pilot, programmer, etc.) must be securely mounted when competing. All functions or values must be pre-set prior to this point.

Any use of Electronic Stability Program - Anti-Lock Brake System - Anti Slip Regulation or any other electronic, pneumatic or manual Driver assisting system is strictly prohibited. The use of Wheel and / or Driveshaft Speed Sensors is prohibited and those must be removed.

Any device (mechanical, hydraulic, pneumatic, electrical, optical, etc.) other than OEM type, which assists in determining track location of the competitors own or opponent's Vehicle is prohibited.

Discovery of a device which displays, indicates, or transmits "on track" or "track location" type data other than installed by the Organizer, will be grounds for immediate exclusion from the event.

Additional penalties may be imposed in accordance with the NSC National Sporting Code.

21. SAFETY

21.1. FIRE EXTINGUISHER SYSTEM

All vehicles must be equipped with a fire extinguishing system meeting FIA Standard “FIA Standard for Plumbed-in Fire Extinguisher Systems in Competition Cars”, (Technical List N°16) or FIA Standard 8865-2015 (Technical List N°52). The minimum quantity of extinguishant for systems of Technical List n°16 is 4 kg. The system must be approved in order to release the extinguishment into the cockpit and the engine compartment by the means of nozzle outlets. The system installation must comply with Article 253-7.2 of Appendix J to the International Sporting Code, following the manufacturer’s specifications, inside the Drivers compartment, and must be visible from the outside of the Vehicle. Safety pins (if equipped) must be red-flagged and be removed before entering the designated burn out area.

21.2. WINDOW NET

A window net designed according to Article 253-11.2 of Appendix J to the International Sporting Code is mandatory on the Driver side window. Arm restraints complying with SFI Spec. 3.3 can be used in lieu of a Window Net.

21.3. DRIVER RESTRAINT SYSTEM

Minimum 5-point Driver restraint system meeting FIA Standard 8853/98, 8853-2016 mandatory. (see also Appendix J Art. 253-6 of the International Sporting Code)

21.4. ARM RESTRAINTS

Permitted if Window Net is used, otherwise mandatory.

21.5. HEAD AND NECK RESTRAINT DEVICE / FHR

The use of a head and neck restraint system is mandatory.

The device or system must meet FIA Standard 8858-2002 or 8858-2010 and must display a valid label accordingly.

21.6. PROTECTIVE CLOTHING

The use of synthetic, non-flameproof materials in contact with the driver’s skin is not permitted. A Driver Suit including long underwear, Gloves, Footwear and Balaclava meeting FIA Standard 8856-2000 or 8856-2018 mandatory. Chapter III – Drivers’ Equipment, Article 2 “Flame-resistant clothing”, Appendix L to the FIA ISC must be respected.

21.7. HELMET

A full-face helmet and visor meeting FIA Standards 8858-2002, 8858-2010, 8859-2015, 8860-2004, 8860-2010, 8860-2018, mandatory. The helmet visor must be closed at all time during on-track activities.

No modifications or attachments such as cameras, etc. are permitted unless approved in the original homologation. It is recommended that drivers use a balaclava homologated to FIA 8856-2000 or FIA 8856-2018 standard, and that is indicated in the technical lists as a balaclava that reduces the loads transmitted to the driver’s neck while the helmet is being removed.